

frozen corner

design Matteo Ragni +
Maurizio Prina

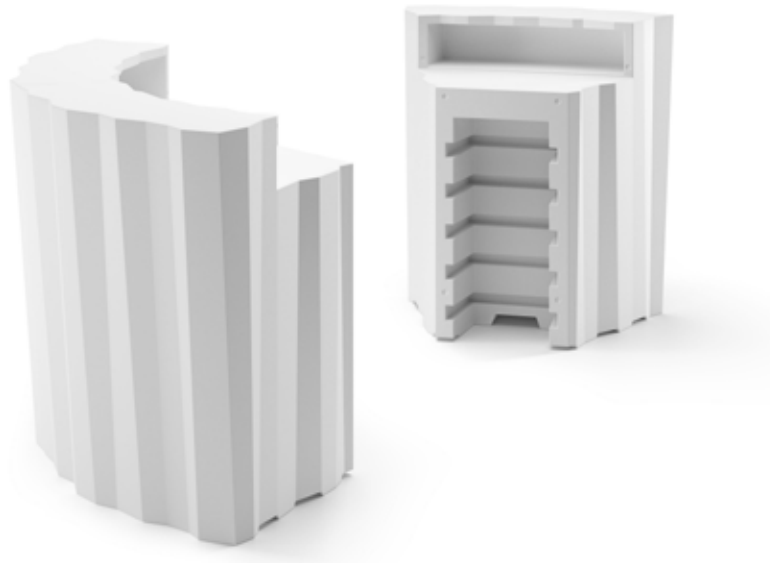

ESTRUCTURA

PE - Polietileno
color básico

6309

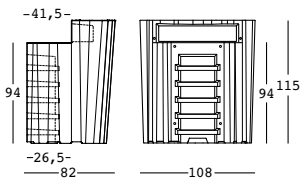
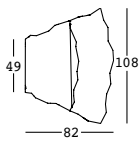

PESO BRUTO:

kg 39,4

DETALLES:

Patas regulables
Kit de fijación

COMPLEMENTOS:

A4526

Parte superior

A4529

Kit repisa

A4409

Kit 4 ruedas

A4656

Sistema de fijación en el
suelo

A4601

Kit de arena seca

frozen corner light

design Matteo Ragni +
Maurizio Prina

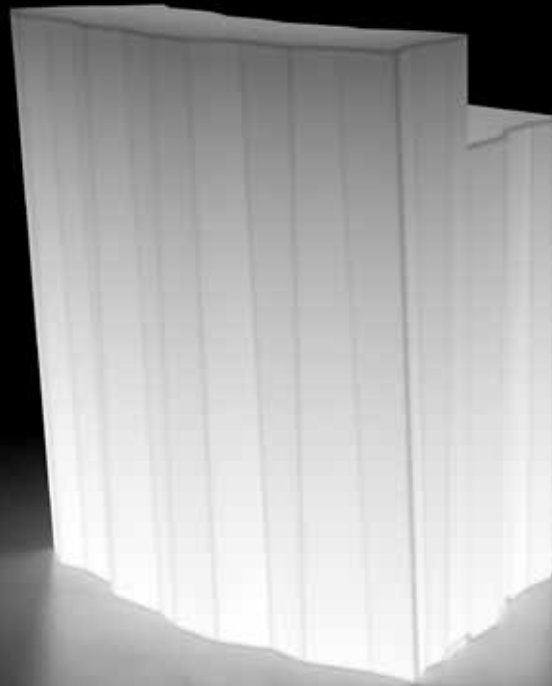

ESTRUCTURA

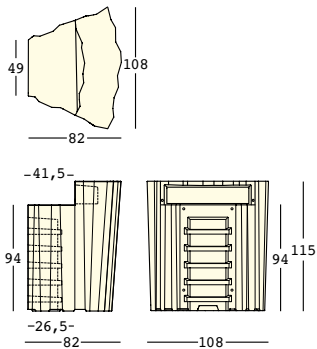

PESO BRUTO:

kg 39,4

DETALLES:

Patas regulables
Kit de fijación

COMPLEMENTOS:

A4526
Parte superior
A4529
Kit repisa
A4409
Kit 4 ruedas
A4656
Sistema de fijación en el
suelo

PE - Polietileno
color básico

8309



98

KIT LUZ

A4182 - exterior



detalles

Carcasa de policarbonato
Junta de estanqueidad
Cable negro
Enchufe Schuko antisalpicadura
Longitud del cable 280 cm
Predisposición para la base de
estabilización

LUZ 1 x 20 W



frozen corner complementos



A4526 frozen corner parte superior

MATERIAL:

Polietileno alimentario

PESO BRUTO:

A4529 kg 2,8

DETAILS:

Completo con 4 tornillos de acero inoxidable

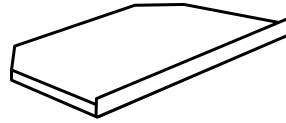

A4529 frozen corner kit repisa

MATERIAL:

Polietileno alimentario

PESO BRUTO:

A4529 kg 1,9

DETAILS:

Completo con 4 tornillos de acero inoxidable

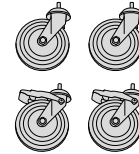

A4409 kit 4 ruedas

MATERIAL:

Acero
Goma

PESO BRUTO:

A4410 kg 1,6

DETAILS:

2 ruedas sin freno + 2 ruedas con freno