

AVVERTENZE / WARNING / AVERTISSEMENTS / ADVERTENCIAS:

- Montare le ruote con freno sul lato operatore.
- Per una maggiore stabilità ruotare le ruote verso l'esterno dell'articolo.
- *Mount the wheels with the brake on the side of operator.*
- *For more stability, turn the wheels towards the ends of the article.*
- *Montez les roues avec frein côté opérateur.*
- *Pour une meilleure stabilité, tournez les roues vers l'extérieur de l'article.*
- *Montar las ruedas con freno del lado operador.*
- *Para mayor estabilidad, girar las ruedas hacia afuera.*

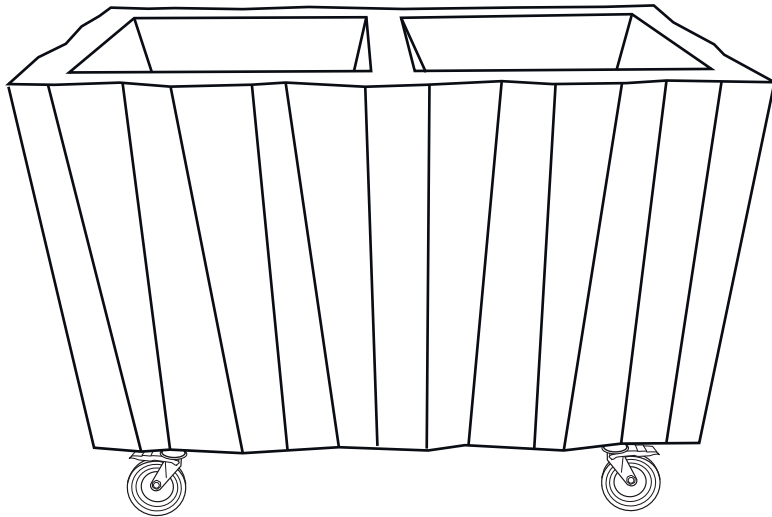

PLUS+[®]
PLUSTCOLLECTION

SCHEMA DI FISSAGGIO /
FIXING INSTRUCTION /
SCHÉMA DE FIXATION /
ESQUEMA DE FIJACIÓN

KIT RUOTE / WHEELS KIT /
KIT 4ROUES / KIT RUEDAS





ART. A4681

FROZEN CATERING COUNTER

KIT RUOTE / WHEELS KIT

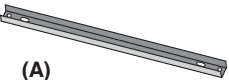
KIT ROUES / KIT RUEDAS

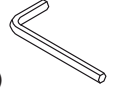
Elementi / Components / Éléments / Elementos:

				
(A) 2x Staffa metallica Metal bracket Bride métallique Placa de unión metálica	(B) 4x Vite M8 M4 screw Vis M8 Tornillos M8	(C) 1x Chiave a brugola da 6 mm. Allen wrench 6 mm. Clé Allen de 6 mm. Llave Allen de 6 mm.	(D) 2x Ruota Wheel Roue Rueda	(E) 2x Ruota frenante Braking wheel Roue freinante Rueda frenante

1° STEP / ÉTAPE / FASE

Ribaltare Frozen Catering Counter come da immagine. Applicare le staffe (A) alla base dell'articolo tramite le viti in dotazione (B) e fissarle con l'ausilio della chiave a brugola (C).

Turn the Frozen Catering Counter on its side as shown in the picture. Attach the brackets (A) to the base using the screws supplied (B) and secure them with the Allen key provided (C).

Basculez le Frozen Catering Counter comme indiqué sur la figure. Appliquez les brides (A) sur la base de l'article à l'aide des vis (B) fournies et serrez avec la clé Allen (C).

Volcar el Frozen Catering Counter como se muestra en la imagen. Aplicar las abrazaderas (A) en la base del artículo usando los tornillos (B) entregados y fijarlos con la ayuda de la llave Allen (C).

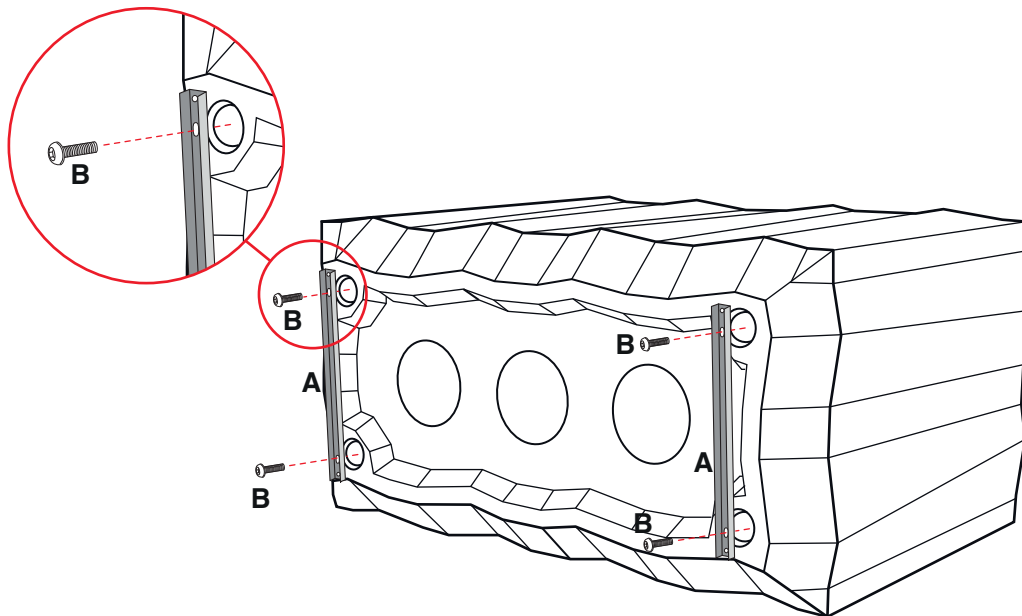

2° STEP / ÉTAPE / FASE

Avvitare manualmente le ruote (D-E) sulla sede prevista nella staffa metallica (A).

Manually tighten the wheels (D-E) into their pre-set positions in the metal bracket (A).

Vissez les roues (D-E) à la main dans les trous prévus sur la bride métallique (A).

Enroscar manualmente las ruedas (D-E) en el alojamiento previsto en la abrazadera metálica (A).

